



# TRACK EVENTS

**Dr. J. GLORY DARLING MARGARET**

**ASSOCIATE PROFESSOR**

**YMCA COLLEGE OF PHYSICAL EDUCATION,  
NANDANAM, CHENNAI**

# TRACK EVENTS



## SPRINT EVENTS

## MIDDLE DISTANCE

## LONG DISTANCE

## HURDLES

## RELAY RACES

## STEEPLE CHASE

100 M  
200M  
400M

800 M  
1500M

3000M  
5000M  
10,000M

100M  
110M  
400M

4x100m  
4x400m

2000M  
3000M



# TRACK EVENTS- RULE 160

Track length- 400m

Two straights & Two curves

Straight – 84.39 mts

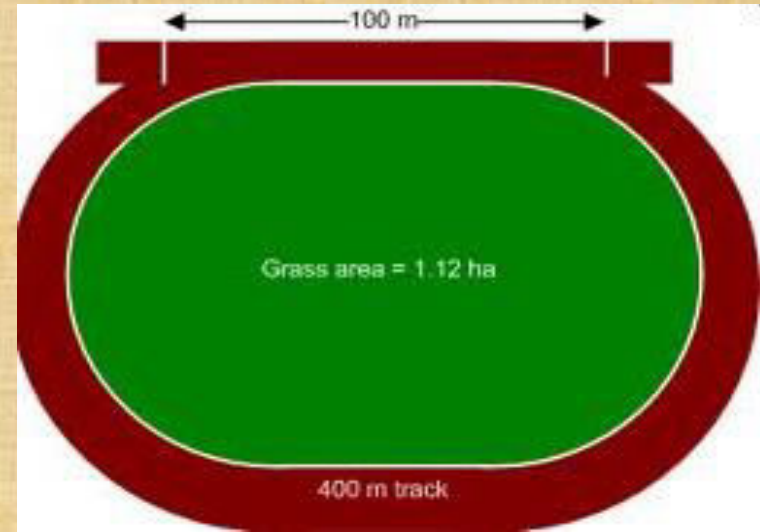

**KERB- 5mx 5m width- white**

**Kerb *on* straight may be omitted  
and 5 cm line can be drawn**



If kerb to be removed on curves-

5cm white lines- **cones or flags(60degree )-**

**20cm ht- 4m interval**

**-Split starts 10m intervals**



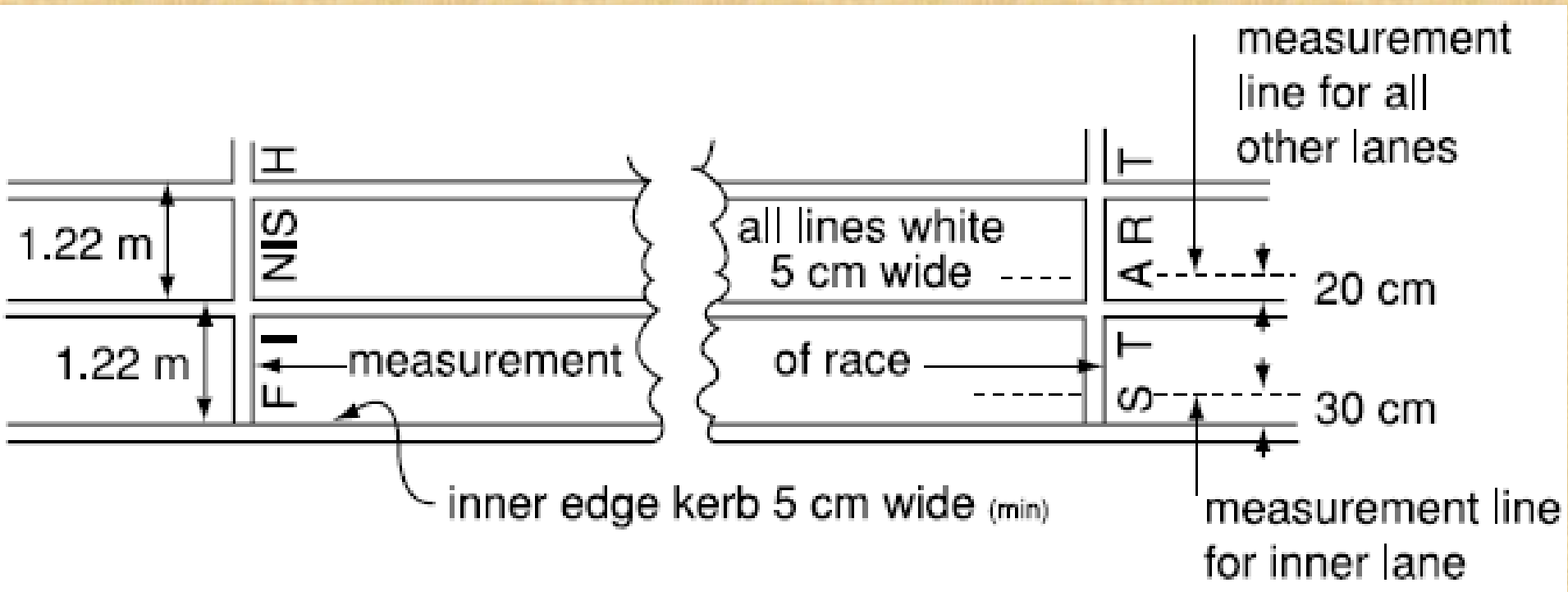

- **Lane- 1.22m**
- **Lateral inclination** of track- 1:100(not to exceed) new track- lateral inclination is towards inside lane
- **Overall inclination** in running direction— 1:1000(not exceed) downwards



# STARTING BLOCKS

- Used for all races up to and including 400m
- Rigid and no unfair advantage to athlete
- Own block- comply with rules , may be of any design or construction
- Should not interfere with other athletes
- Consists of two foot plates on rigid frame
- Surface of footplates should accommodate spikes
- Foot plates should be adjustable but no movement during start



# CLOTHING

- Wear **clean**, **non transparent** even if wet
- Athletes vest should have **the same color on the front and back**
- Uniform should be **approved by their National Governing Body**



**Christopher Taylor** on his way to **winning the 400m at the IAAF** World Youth Championships,



# SHOES

- Athlete may compete barefoot or with footwear on one or both feet
- Should not give any unfair additional assistance
- Unfair advantage
- Shoe strap over the instep is permitted
- All types of competitions shoes must be approved by WA



# THE START

- Denoted by white lines 5cm wide
- Races which are not in lanes be in curves
- **Lane numbered from left to right** in direction of running
- All races **up to and including 400m**

**Crouch start**

**Starting blocks are compulsory**

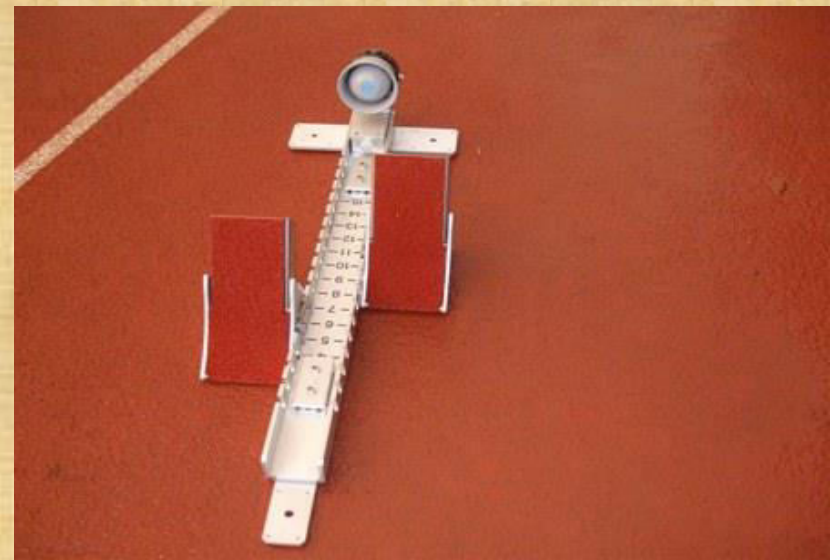

- Starter can **use command only in English** in World Athletics series
- Olympic Games
- Competitions not from single area
- International Invitation meets under WA
- Inter area competitions



- If the **starter is not satisfied** after athletes are on their marks- **order athletes to withdraw**
- Except in international matches starter can use commands in his own language, **English** or in French
- Up to and including all races 400m

**“ON YOUR MARKS”...**

**“SET “ ...**

**GUN SHALL BE FIRED..**



After start commands  
before gun if athletes  
comes out of blocks  
misconduct – **RED  
CARD**

Referee shall **warn the  
athletes**

- Without valid reason (raising hands, delay, standing etc)
- Disturbs other athletes by sound
- Starter shall abort the start

**Green card**

- **If extraneous reason  
for aborting the start**



# FALSE START

- After assuming final start position, shall not commence his start- if so disqualified
- **Red card** is shown to the athlete



# FALSE START - VIDEO

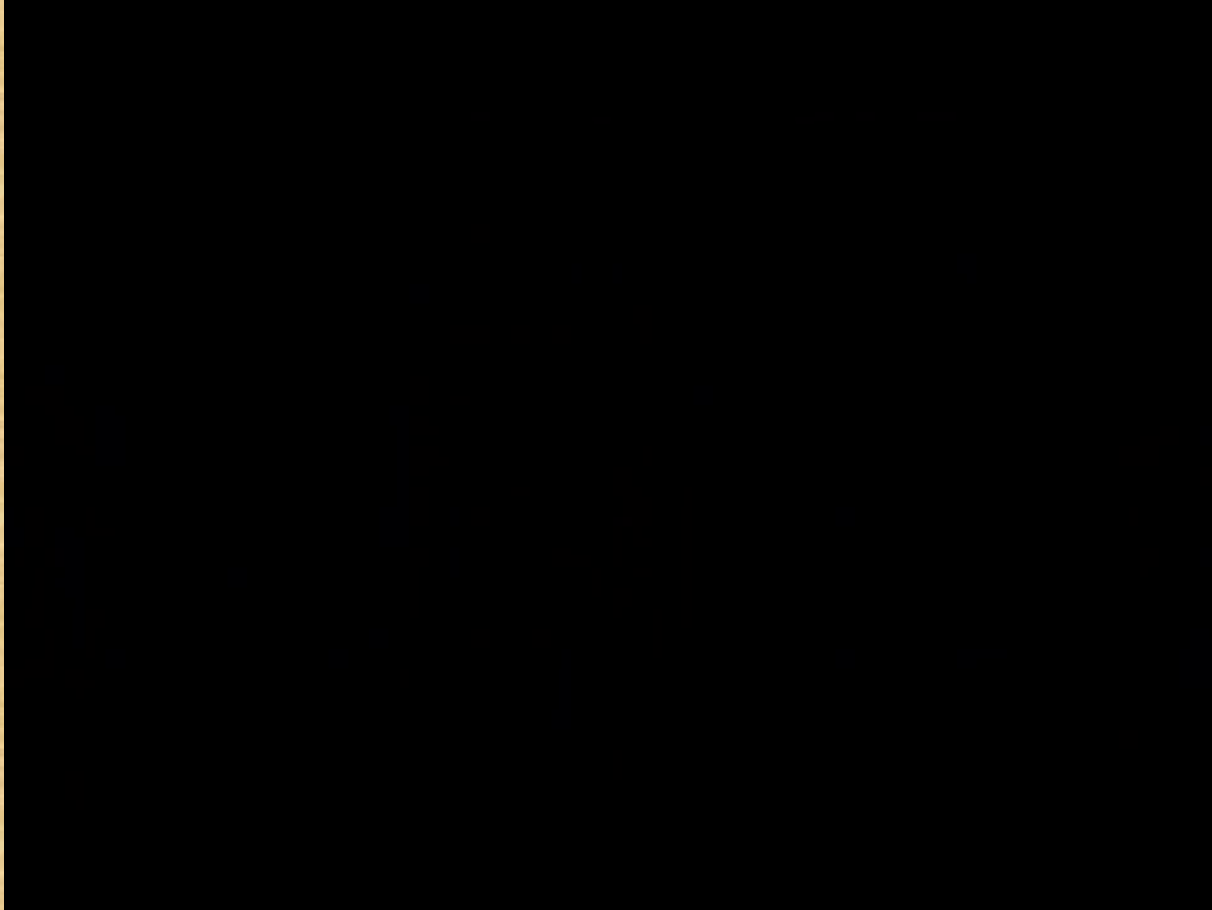

- After false start duties of Starter's Assistant  
\*\*athletes shall be disqualified  
show **red card and black diagonally halved card is showed** in front of him  
respective lane markers





# FALSE START



- **Ronnie Ash of the United States reacts** after being disqualified for a false start in the Men's 110 metres hurdles heats during day five of the 15th IAAF World Athletics Championships Beijing 2015 at Beijing National Stadium on August 26, 2015 in Beijing, China.

**Yongli Wei of China is shown a red card and disqualified** by the chief judge after false starting during the women's 4x100 metres heats during day nine of the 13th IAAF World Athletics Championships at the Daegu Stadium on September 4, 2011 in Daegu, South Korea.

- When an WA approved false start control apparatus is in use, the Starter and/or an assigned Recaller shall wear headphones in order to clearly hear the acoustic signal emitted when the apparatus indicates a possible false start (i.e. when the reaction time is less than 0.100 second).
- As soon as the Starter and/or an assigned Recaller hears the acoustic signal, and if the gun was fired, there shall be a recall and the Starter shall immediately examine the reaction times on the false start control apparatus in order to confirm which athlete(s) is/are responsible for the recall.

*Note (i): Any motion by an athlete that does not include or result in the athlete's foot / feet losing contact with the foot plate(s) of the starting blocks, or the athlete's hand / hands losing contact with the ground, shall not be considered to be the commencement of his start. Such instances may, if applicable, be subject to a disciplinary warning or disqualification*

# FALSE START - VIDEO



# FALSE START CONTROL APPARATUS

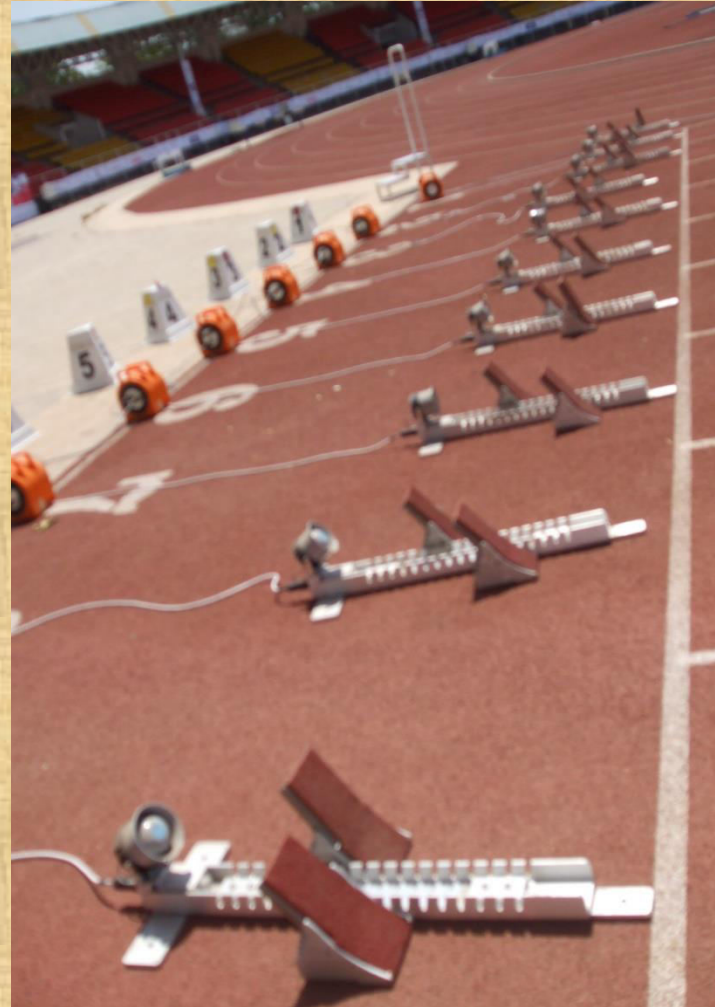

International competitions/ record performance **starting blocks are linked to WA approved false start control apparatus**

# THE FINISH

- Denoted by white line 5cm wide
- Athletes placed in order in which **any part of their bodies** ( ie: torso distinguish from head, neck, arms, legs , hand or feet) **reaches vertical plane of the nearer edge of finish line**



# MIDDLE DISTANCE & LONG DISTANCE

**MIDDLE DISTANCE -800 M & 1500M**

**LONG DISTANCE- 3000M, 5000M, &10,000M**



- In races longer than 400m

**ON YOUR MARKS**

**GUN SHALL BE FIRED.....**

**Athletes shall not touch the ground with hands during start**

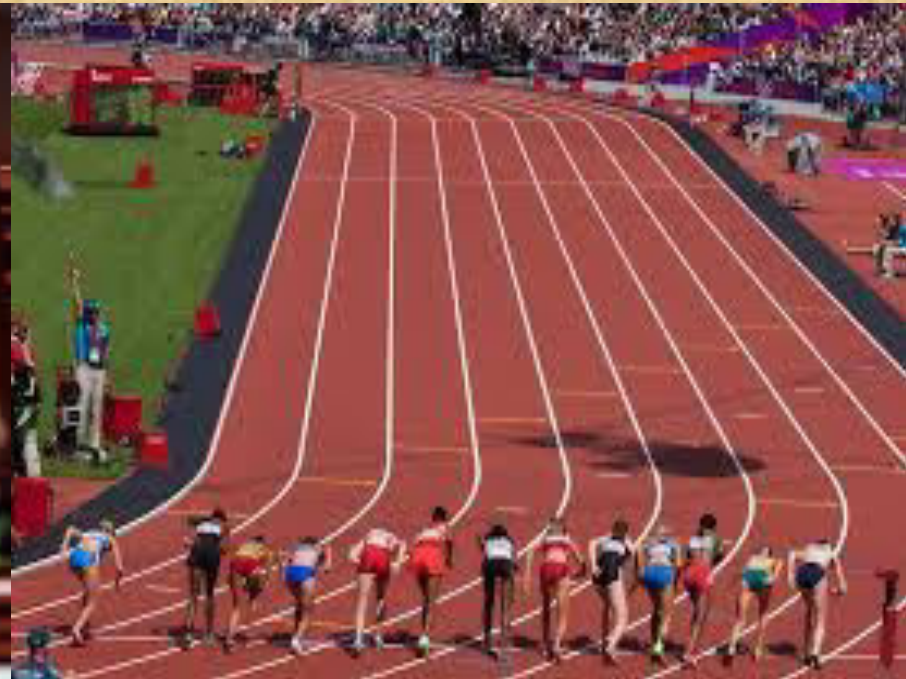

# 800m & 1500m STARTS



**800m- STAGGERED START**  
**HALF STAGGER + DIAGONAL**  
**EXCESS**



**1500M-**  
**STAGGERED**  
**START**



- *The 1500m start line may be extended out from the outside bend lane to the extent that the same synthetic surface is available.*



- **International competitions 800 m shall be conducted in lanes ( till break line in first bend)**



# 3000m, 5000m & 10000 m STARTS

## SPLIT STARTS

- When **more than 12 athletes**
  - two groups **65%- regular arced start line**
  - **35%- separate arc start line marked across the outer half 5 x 5cm white line** (cones or flags)  
All athletes are positioned that they run same distance

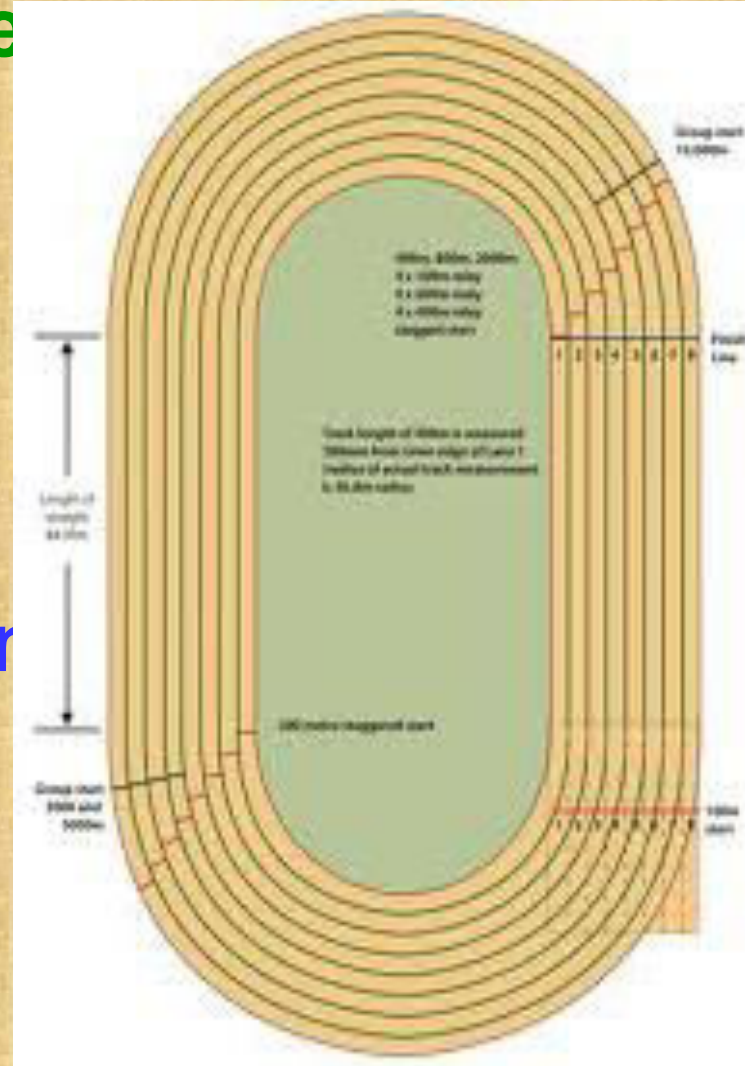

# BREAK LINE

Break line is drawn at the start of straight 84.39m in the back straight in an arc form

**5cm wide-across** all lanes except lane 1- identified with small **cones 5cmx 5cm not more than 15cm high-** different color- placed on lane lines before intersection of laneline and break line

cones 5cmx  
5cm not more  
than 15cm high-



# THE RACE -

## DISQUALIFICATION

- Athlete obstructs another athlete
- An athlete running on bend shall not run on or inside the kerb or line marking.



## RE RACE

- Referee has the authority to Conduct **re race** excluding disqualified athlete
- If preliminary round, **allow to compete** in subsequent round
- Such athlete should have completed the event with **bona fide effort**
- Regardless of whether any disqualification in exceptional cases referee has the authority for re race if reasonable



## ATHLETES - NOT TO BE DISQUALIFIED

- ❖ runs outside his lane in straight
- ❖ Or outside the outer line of his lane on the bend
- ❖ With no material advantage being gained can continue his race no other athlete being obstructed



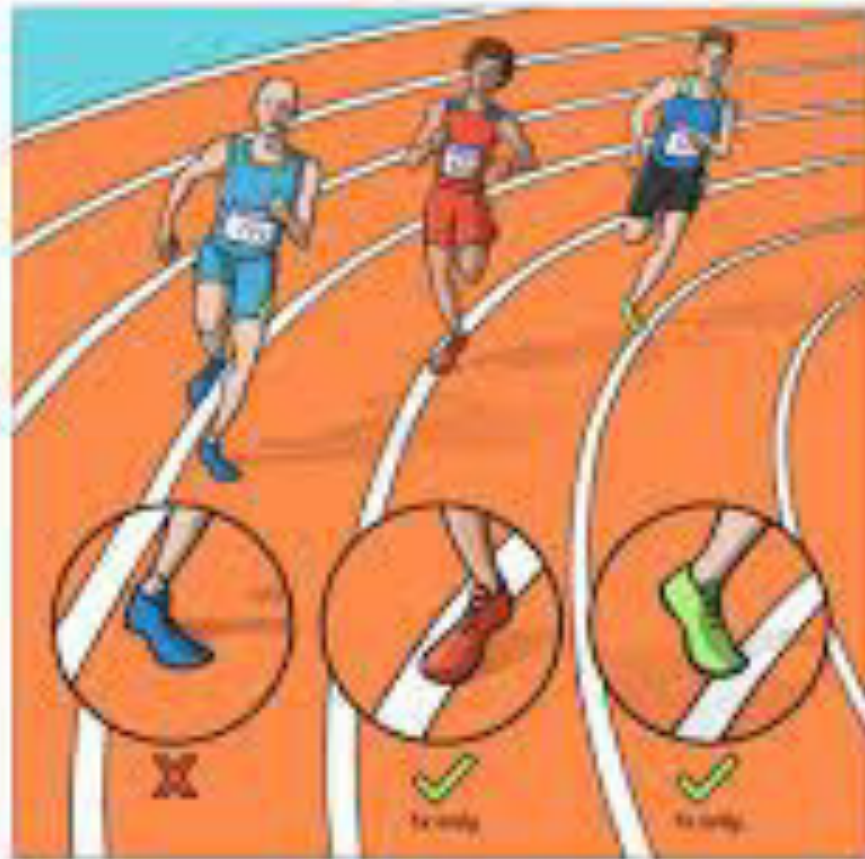

**Athlete shall not be  
disqualified**

**pushed or forced by  
another person**





# Obstruction

- 2. If an athlete is jostled or obstructed during an event so as to impede his progress, then:
- (a) if the jostling or obstruction is considered unintentional or is caused otherwise than by an athlete, the Referee may, if he is of the opinion that an athlete (or his team) was seriously affected, order that the race be re-held or allow the affected athlete (or team) to compete in a subsequent round of the event;



Athlete after **voluntarily leaving** the track shall **not be allowed** to continue the race



# WIND GUAGE- measures wind velocity



## Equipment should be certified by IAAF

- Started and stopped automatically and or remotely
- Information conveyed directly to competition computer



## READINGS IN WIND GUAGE

- Measured in **m/sec**
- +2.03 m/sec is +2.1 m/sec (positive direction)
- 2.03 m/sec is 2.0 m/sec



# POSITION OF WIND GUAGE

- Beside straight- **adjacent to lane 1-**
- **1.50m from finish line**
- 1.22m height
- not more than **2m away from track**



- The period of **wind velocity** shall be measured from the **flash of the starters gun**
- **100 m- 10 sec**
- **200m- 10 sec** when 1<sup>st</sup> athlete enters the straight
- **100m hurdle- 13sec**
- **110m hurdle- 13 sec**



# TIMING AND PHOTO FINISH



- **Hand timing**
- Fully automatic timing obtained from a **photo finish system**
- Timing provided by **transponder system**
- Times for **all finishers shall be recorded**
- **Lap times in races of 800m and over and intermediate times at every 1000m in races 3000m and over shall be recorded**



# TIMING

## HAND TIMING



## FULLY AUTOMATIC





# HAND TIMING

- Time keepers shall be in line with finish line- **5m away- elevated stand**
- Use manually operated electronic timers with digital read outs- termed as “watches”
- Time shall be taken from the **flash /smoke** of the gun  
**3 official TK (1 Chief TK- 1 OR 2 Add.TK)- for Winner of the event**



# TIME KEEPER

- act independently
- **Not show watch or discuss time**
- **enter his time on official form**
- **sign**
- **hand over to chief time keeper**
- **Chief TK decide** official time for each athlete and provide the results to **competition secretary**



## Timing For Races On Track

**100m- 10.11sec is recorded as 10.2 sec**

## Partly or entirely outside stadium

**Marathon- 2:09:44.3 recorded as 2:09:45**

**In 3 watches – 2 agree and 1 disagree=time recorded by 2 watches will be official time**

**If all 3 watches disagree-middle time shall be the official**

**If only 2 times available and disagree- longer time shall be official**

# FULLY AUTOMATIC TIMING AND PHOTO FINISH SYSTEM

- System **approved by IAAF-** Test for accuracy 4 yrs prior to competition
- Started **automatically by the starters gun**
- The system must record the finish through a camera **positioned in the extension of finish line** producing a continuous image
- The **intersection of the lane lines and finish line shall be coloured black not more than 2cm beyond or before edge of finish line**
- The system automatically record finish times and produce printed image showing time of every athlete

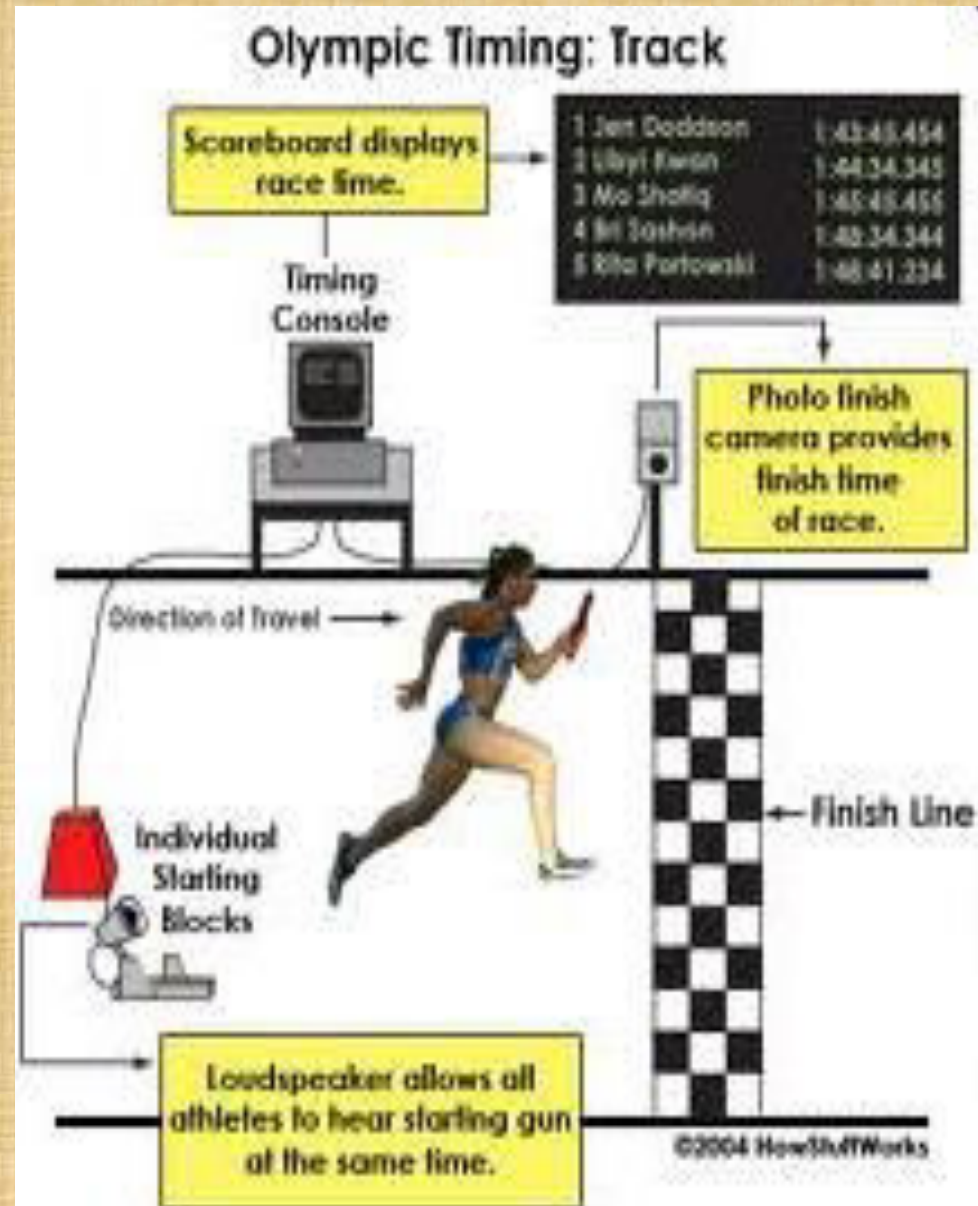

- **Chief photo finish judge** is responsible for functioning the system
- **Two assistant PFJ** with **CPFJ** determine the placing and time of each athlete
- **Convey results to competition secretary**
- **Meet technical staff to familiarize with equipment**
- **With track referee and starter conduct “zero test” before competition to ensure that the equipment is started automatically by the starters gun**
- **At least Two photo finish cameras one from each side of the track and technically independent( 1 designated as official by the technical delegate)**

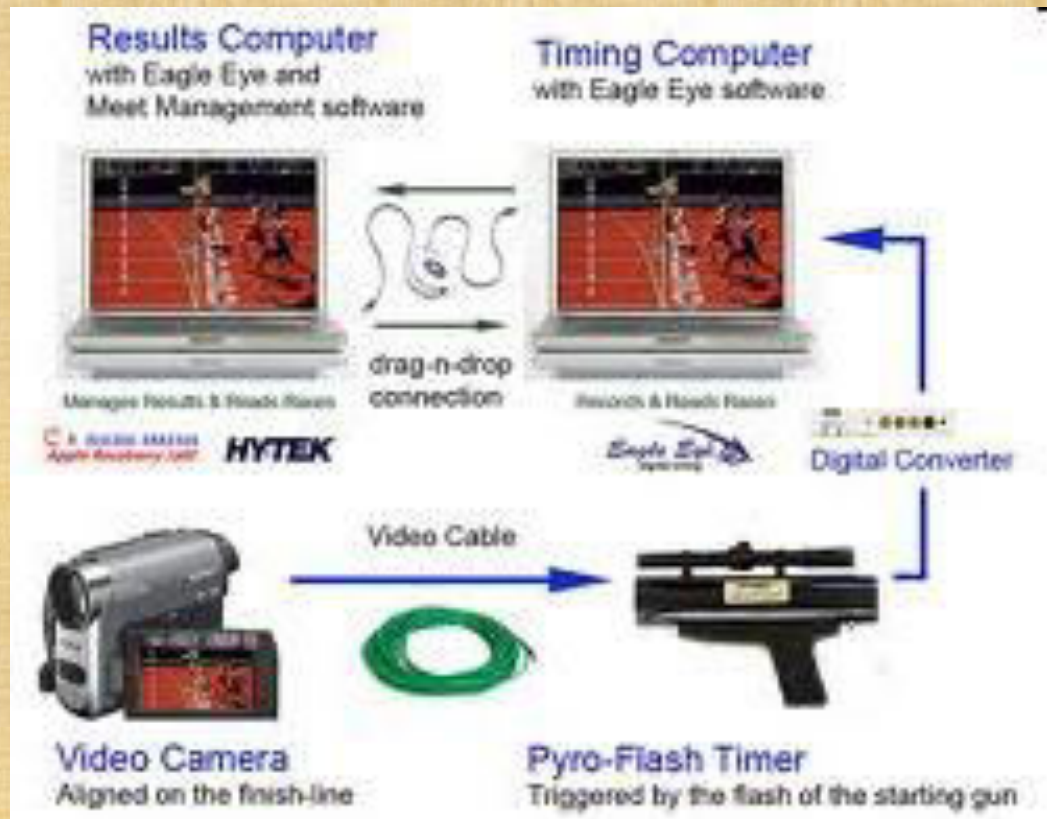

- Time from Photo finish image is recorded as

- Races up to and including
- 10'000m(1/100) as 26:17:53

- For all races on track longer than 10000m

Eg: 20,000m, 59:26:32(1/100<sup>th</sup>) shall be recorded as

59:26:4(1/10<sup>th</sup>)

- For all races partly or entirely outside the stadium

Time shall be read to 1/100<sup>th</sup> and recorded to whole second

Eg: Marathon 2:09:44.32 as 2:09:45



# TRANSPONDER SYSTEM

- Approved by IAAF
- Used for races 800m and above held completely in or outside the stadium( Race walking,Road races &Cross country running)
- No obstacle to athlete while running
- Weight of transponder, housing carried on athletes uniform, bib , shoe not significant
- System is started with **starters gun or synchronized with start signal**
- System requires no action by athlete during competition
- Time recorded as Eg:Marathon 2:09:44.32 as 2:09:45



# TIES

- If the judges or photo finish judges are **unable to separate** the athletes for any place – **TIE Shall remain**
- If tie between athletes in different heats for
- **1. ranking**
- **2. qualifying position** -For subsequent round based on time
- For qualifying position tying athletes shall be placed in **next round if not possible, lots shall be drawn**

Chief photo finish judge shall consider time **to 1/1000<sup>th</sup> of second**

- If tie remains- tie shall be broken by **draw**





# HURDLES



China's Wu Shuijiao (R) competes during the women's 100m hurdles semifinal at the 2015 IAAF World Championships at the "Bird's Nest" National Stadium in Beijing, capital of China, Aug. 28, 2015. (Xinhua/Wang Lili)

# Hurdle Races

Example of a Hurdle

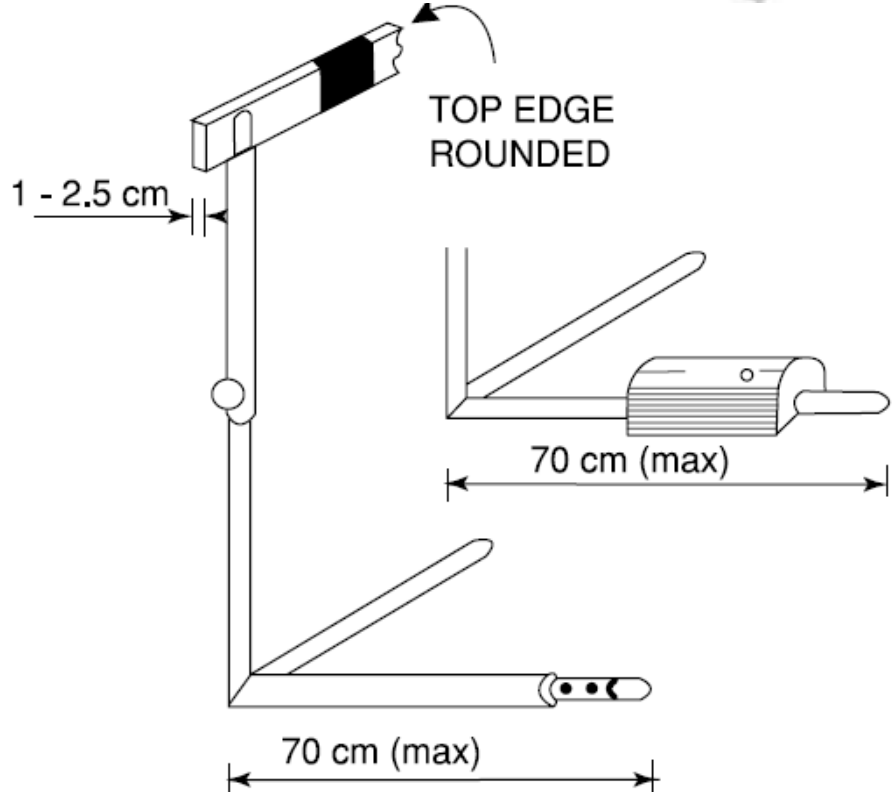
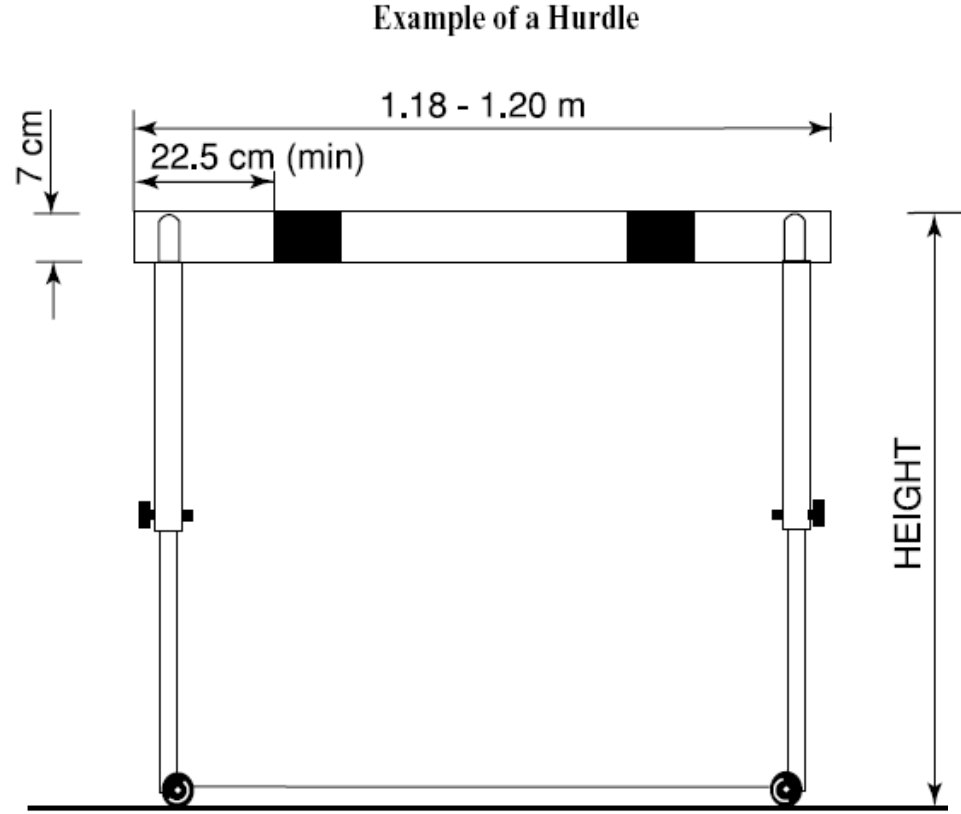

# 10 flights of hurdles in each lane



<b>GENDER</b>	<b>DISTANCE OF RACE</b>	<b>HEIGHT OF THE HURDLE</b>	<b>DISTANCE FROM START TO 1<sup>ST</sup> HURDLE</b>	<b>DISTANCE BETWEEN HURDLES</b>	<b>DISTANCE FROM LAST HURDLE TO FINISH LINE</b>
<b>MEN</b>	<b>110M 400m</b>	<b>1.067 m 0.914m</b>	<b>13.72m 45.00m</b>	<b>9.14m 35.00m</b>	<b>14.02m 40.00m</b>
<b>women</b>	<b>100m 400m</b>	<b>0.838 m 0.762 m</b>	<b>13.00 m 45.00 m</b>	<b>8.50 m 35.00 m</b>	<b>10.50 m 40.00 m</b>

- All races shall be run in lanes
- **An athlete shall be disqualified, if he:**
- (a) **does not jump any hurdle,**
- (b) **trails his foot or leg below the horizontal plane,**
- (c) **jumps any hurdle not in his own lane, or**
- (d) **in the opinion of the Referee deliberately knocks down any hurdle**



- knocking down of hurdles with hands- foul
- knocking down of hurdles with legs shall not result in disqualification nor prevent a record being made.
- For a **World Record** all hurdles must comply with the specifications of this Rule.



# Steeplechase Races



Ezekiel Kemboi proving that he's the consummate championship competitor by taking his fourth consecutive world title and seventh straight medal at the IAAF World Championships.



Hyvin Kiyeng Jepkemoi of Kenya celebrates winning the women's 3,000 metres steeplechase final during the 15th IAAF World Championships at the National Stadium in Beijing

- The standard distances shall be **2000m and 3000m**
- 3000m- 28 hurdle jumps and 7 water jumps
- 2000m event- 18 hurdle jumps and 5 water jumps



3.94m minimum

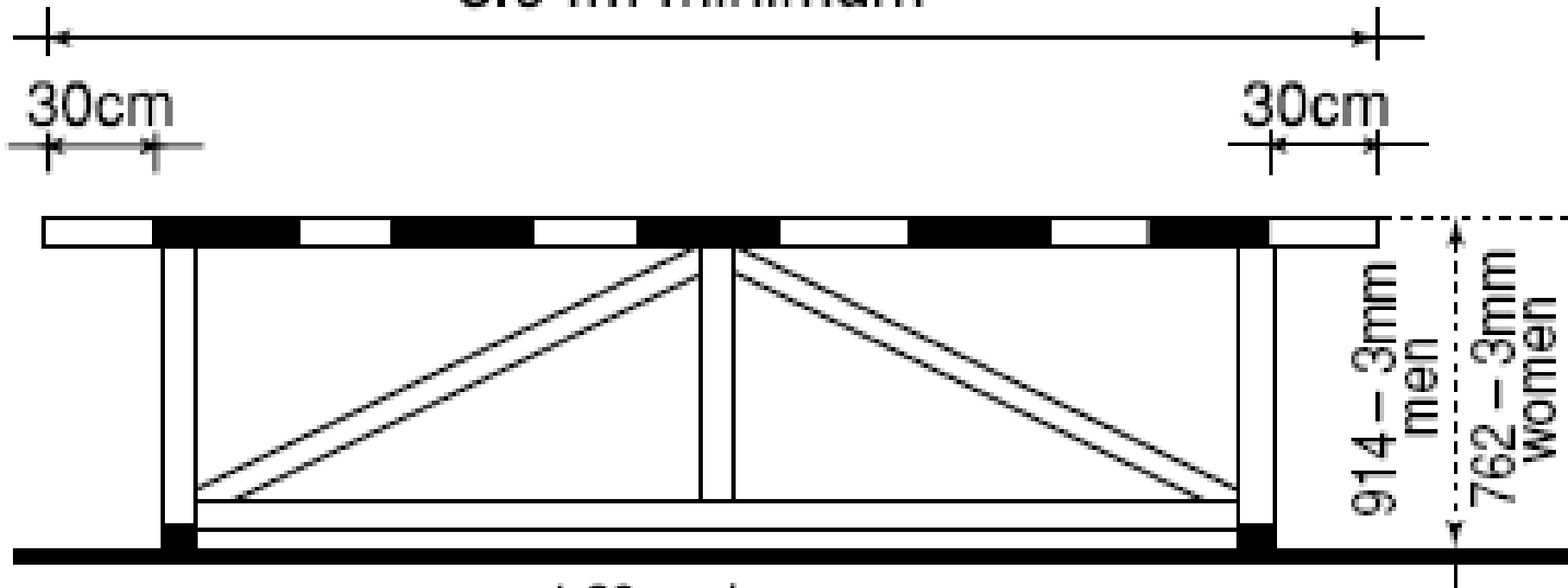

1.20m min. -  
1.40m max.



12.7cm x 12.7cm

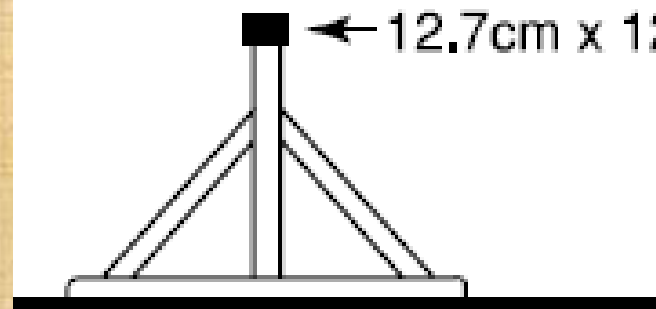



# 3000m Steeple chase

- **5 jumps in each lap (water jump as the 4th )** after the finish line has been passed for the first time,
- The jumps shall be evenly distributed, so that the **distance between the jumps is one fifth of the nominal length of the lap.**
- The distance from the **start to the beginning of the first lap shall not include any jumps,**
- **Hurdles should be removed until the athletes have entered the first lap**

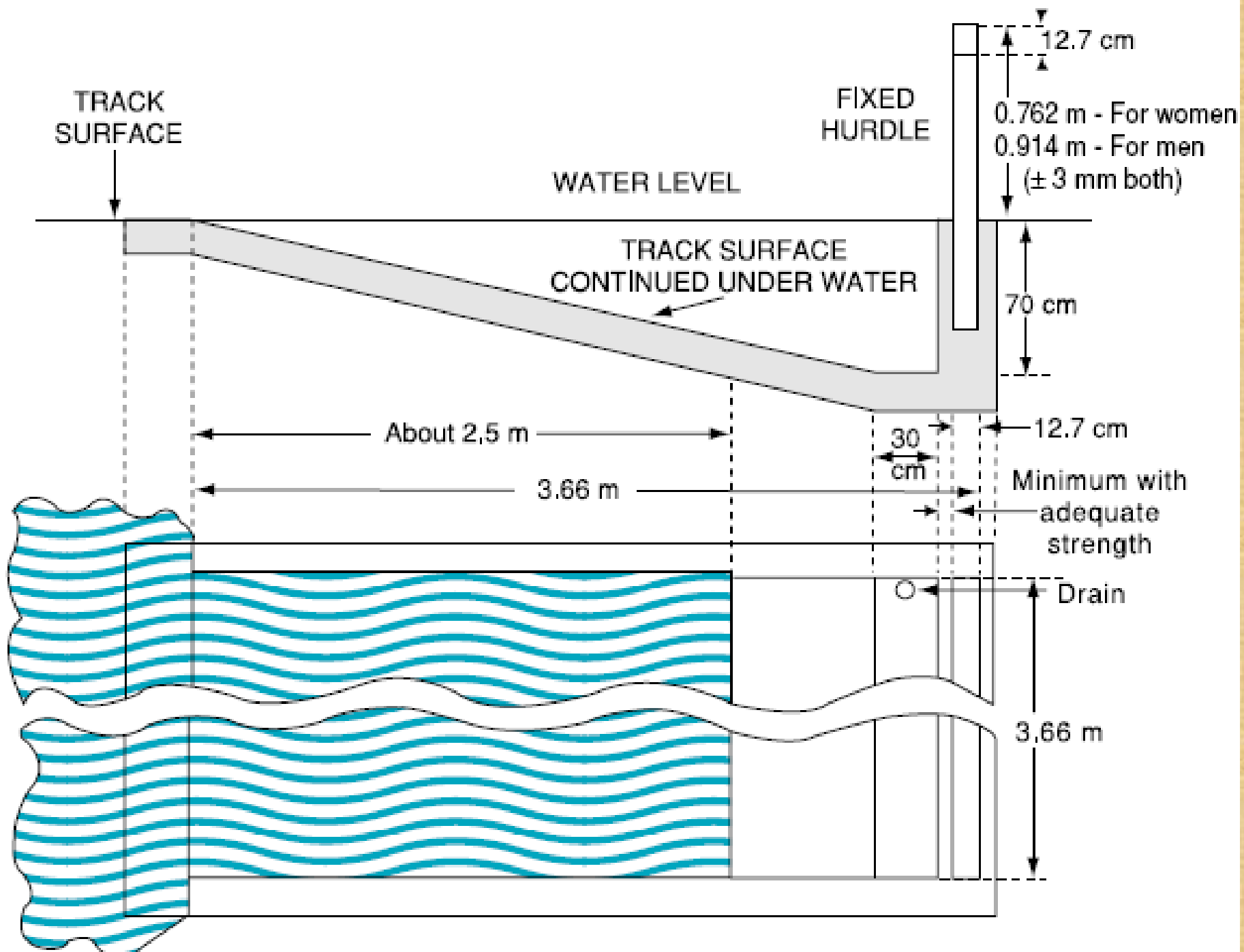

# 2000m Steeple chase

- *If the water jump is on the **inside of the track**, the finish line has to be passed twice before the first lap with five jumps.*
  - The first jump is at the **third barrier of a normal lap.**
  - The previous hurdles shall be removed until the athletes have passed them for the first time.
- Note:** *It is recommended that the first hurdle taken in the race should be at least 5m in width.*

(a) The athlete shall go over or through the water **Water jump/ Hurdle**

**An athlete shall be disqualified, if**

- (a) **does not jump any hurdle,**
- (b) **steps to the one side or other of the water jump, or**
- (c) **trails his foot or leg below the horizontal plane** of the top of any hurdle at the instant of clearance.

Provided this Rule is observed, an athlete may **go over each hurdle in any manner.**



# RELAY RACES



# RELAY RACES

- 4x100 m  
take-over zone shall be **30m long**
- **Check-Marks.**  
one check-mark on his lane  
adhesive tape,  
maximum **5cmx40cm**  
distinctive color



# BATON

- Smooth hollow tube, circular in section
- wood, metal or any other rigid material in one piece
- **length - 28 to 30cm.**
- **circumference - 12 to 13cm**
- **weight- not less than 50g**
- It should be colored



- Baton If dropped, it shall be **recovered by the athlete who dropped it.**
- He may leave his lane to retrieve the baton he **does not lessen the distance** to be covered.
- no other athlete **is impeded**





- The baton shall be carried by hand throughout the race.
- Athletes are not permitted to wear gloves
- No substances on their hands for grip of the baton.
- dropping the baton shall not result in disqualification.



- Passing of the **baton** **outside the take-over zone** shall result in disqualification.
- If an athlete **willfully impedes** a member of, his team shall be disqualified.
- **Assistance by pushing** or by any other method shall result in disqualification



# TEAM

- **Any 4 athletes** from among those entered for the competition, whether for that or any other event, may be used in relay team for any round.
- only **two additional athletes** may be used as substitutes. If a team does not follow, it **shall be disqualified**.
- Team and the order of running be officially **declared 1 hour before 1<sup>st</sup> call time**.
- Alterations must be verified by a **medical officer appointed by the Organising Committee** and may be made only until the final call time.
- If a team does not follow this Rule, it **shall be disqualified.**

# 4x400m relay



- *In 4x400m relay races, where not more than 4 teams are competing, only the first bend of the first lap **should be run in lanes***
- 2nd 3rd and 4th runners **shall start within this zone.**



# TAKE-OVER ZONES

- The scratch lines of the **first take-over zones** for the 4x400m are the same as the start lines for the 800m.(1/2 stagger + DE)
- **2<sup>nd</sup> & 3<sup>rd</sup> take-over zones** will be the 10m lines either side of the start/finish line.
- 2<sup>nd</sup>, 3<sup>rd</sup>, & 4<sup>th</sup> athletes are **not permitted to begin running outside their take-over zones**, and shall start within this zone.
- 3<sup>rd</sup> & 4<sup>th</sup> runners
- **Break line**



- **designated official**, place in their waiting position in the order of their respective team members as they complete 200m of their legs.
- Once the incoming athletes have passed this point, **the waiting athletes shall** maintain their order, and shall **not exchange** positions at the beginning of the take-over zone. If an athlete does not follow this Rule, his team **shall be disqualified**.



# SEEDINGS DRAW AND QUALIFICATIONS IN TRACK EVENTS-







# NEW COMPETITION RULES

## EXPLAINED

### 1 NO MORE EMPTY SPOTS IN FINALS



For finals and semi-finals in all events, including relays, there will be a virtual 'hot seat' policy. The next best ranked athlete(s) or teams (maximum of two for each replacement) will be waiting for any withdrawals. They will have a set time to accept or the place goes to the second ranked athlete or team.

There will be no re-draw of lanes or re-ordering of attempts.



### 2 LANE LOTTERY AFTER ROUND 1

4 TOP RANKED    2 NEXT RANKED    2 LAST RANKED

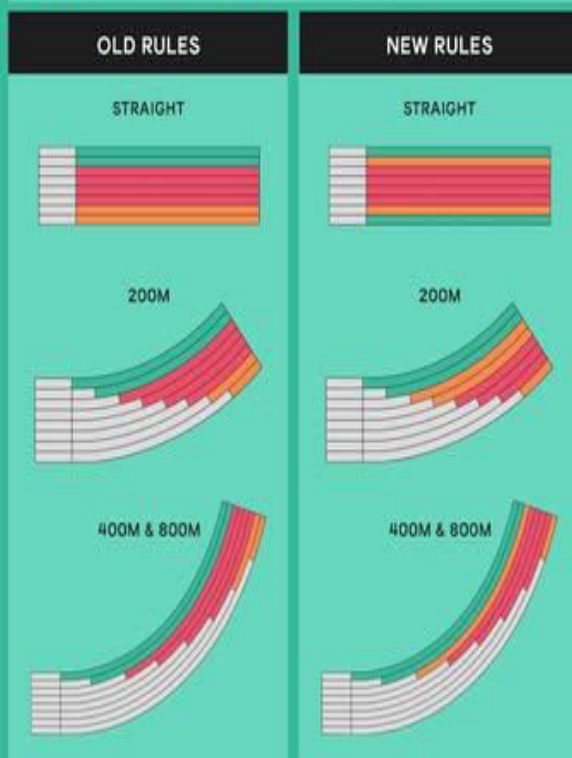

### 3 MIDDLE DISTANCE QUALIFICATION TO NEXT ROUND

In events of distances of 1500m or more, there will now be ONLY automatic qualifiers.

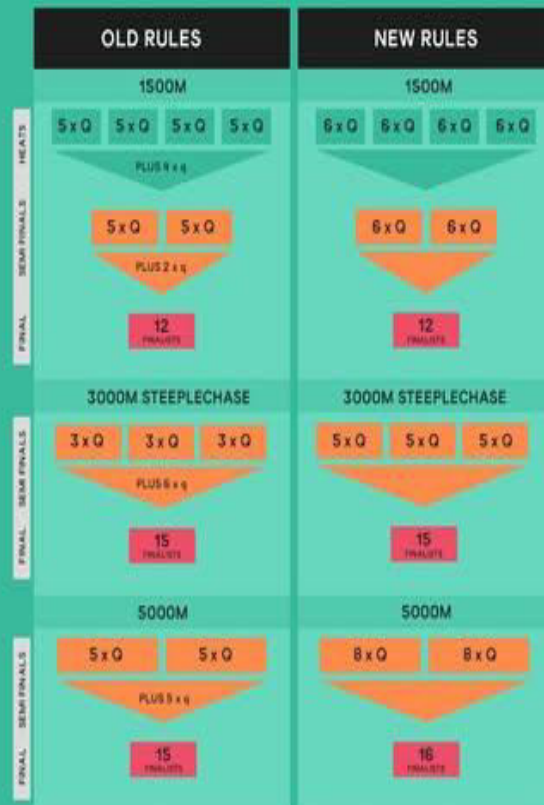

- **Representatives of each nation or team shall be placed in different heats in all rounds of the competition.**
- *When heats are being arranged, **performances of all athletes should be considered and the heats drawn***
- *so that, **the best performers reach the final.***



- **After the first round, the athletes shall be placed in the heats of subsequent rounds :**
- **(a) for events of 100m to 400m inclusive, and relays up to and including 4x400m,**
- **seeding shall be based upon placing of each previous round**



- An athlete shall not be allowed to compete in a heat other than the one in which his name appears, except in circumstances which, in the opinion of the Referee, justify an alteration
- In all preliminary rounds, at least the first and second places in each heat shall qualify for the next round and it is recommended that, where possible, at least three in each heat should qualify.
- The order in which heats are to be run shall be determined by draw after the composition of the heats has been decided

- Minimum time between the last heat of any round and the first heat of a subsequent round or final:
- Up to and including 200m - 45 minutes
- Over 200m up to and including 1000m - 90 minutes
- Over 1000m - Not on the same day





Thank  
you!